



“Horseshoe” Frame/Deflection – Protected I-Beam Penetrations

- **Spray Applied Fire Resistive Material**
- **Tabbed Track (Bottom of Beam)**
- **Mineral Wool Cavity Stuff**
- **"Contour" or "Cope Cut" Gypsum**
- **Alt: BPG & Square Cut Gypsum**

1) **Structural Support** - I-Beam or Open Web Truss Penetration with Spray Applied Material

2) **SFRM** – Spray Applied Fire Resistive Material applied to beam prior to installation of framing

3) **NZB or Z-Clip** – (optional) NZB (Notched Z-Bar) or Z-Clip to extend through Spray Applied Material

Alternate: Attach track through fire proofing with "steel pin" if approved

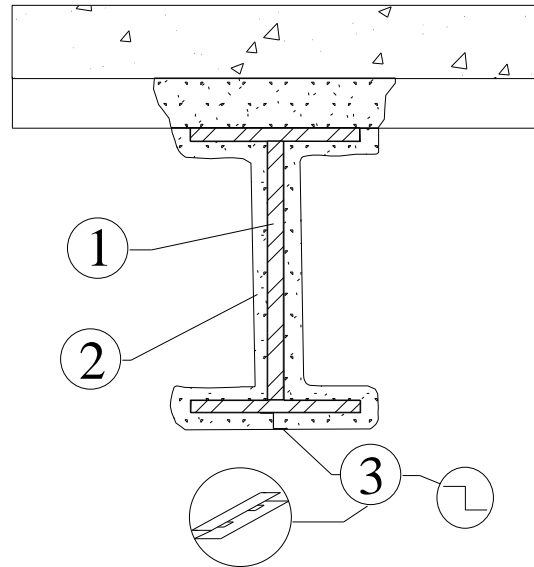

1) **Deflection Track** – Deflection track (slotted or solid leg) profile attached to overhead substrate butting into Spray Applied Material

2) **Tabbed Deflection Track** – Deflection track with web snipped at each end forming attachment tabs

Alternate: Fasten angle clips to create attachment tabs at end of track profile

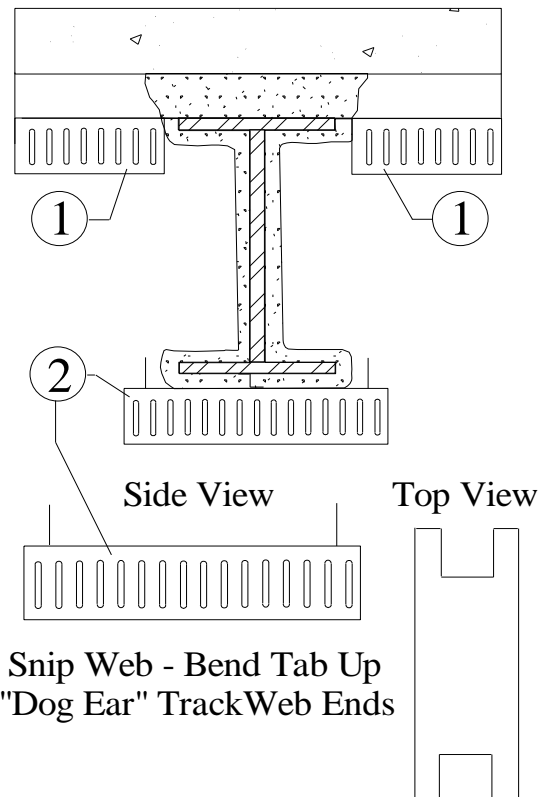



“Horseshoe” Frame/Deflection – Protected I-Beam Penetrations

“Horseshoe” Framing – Deflects & Cycles with Beam & Horizontal Substrate independent of Wall Framing and Gypsum Sheathing

- 1) **Beam Drops** - Beam Drop Backing min. 25ga framing material (Stud or Track profile) to extend from upper deflection track down to deflection track under beam.
- 2) **Attachment** – Fasten Beam Drop sections to upper deflection track and attachment tabs of deflection track under beam with typical steel fasteners

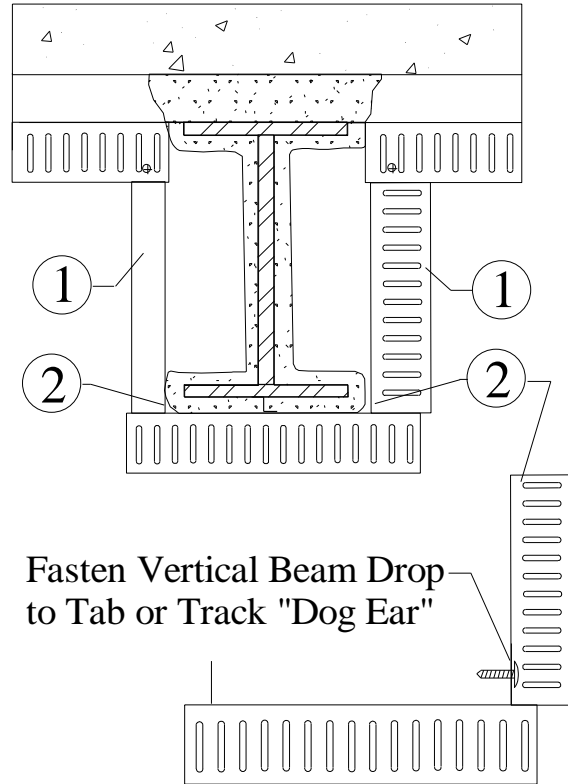

Contour or Coped Drywall Construction

- 1) **Safti-Seal FRG** – Apply Safti-Seal Fire Rated Gasket (FRG) to deflection track and beam drop framing materials continuous

-Horizontally at deck and under beam install FRG width to accommodate specified deflection

-Vertically at beam drop backing a min 3/4" wide FRG (FRG-50) applied continuous from deflection track to deflection track

- 2) **Mineral Wool** – Fill “beam cavity” with min. 4 pcf mineral wool (width of wall framing) compressed a min. 50% filling entire Beam Cavity Void

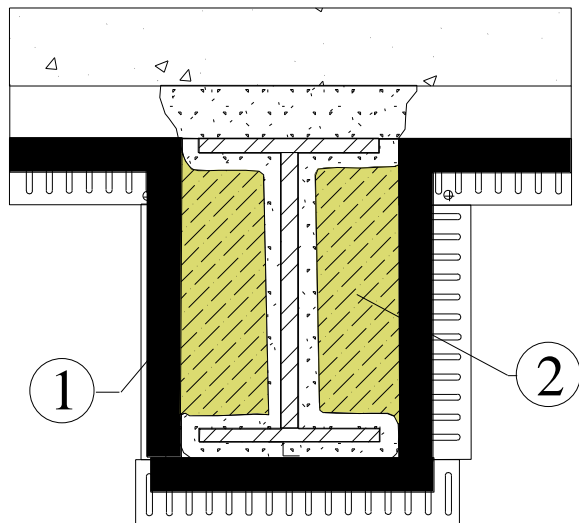



“Horseshoe” Frame/Deflection – Protected I-Beam Penetrations

1) Finished Contour Cut Drywall – Contour cut drywall around beam penetration with a max 3/8” gap between vertical drywall edges and spray applied fire proofing.

-Install drywall at *horizontal conditions* to deck, below beam, and in beam cavity with *appropriate gap to accommodate specified deflection*.

-Max 2.00” Overall Deflection Certified

-No additional sealant required

- Do not fasten wall sheathing to "Horseshoe" framing around beam penetration

- Do not fasten vertical stud framing to vertical “beam drop” framing

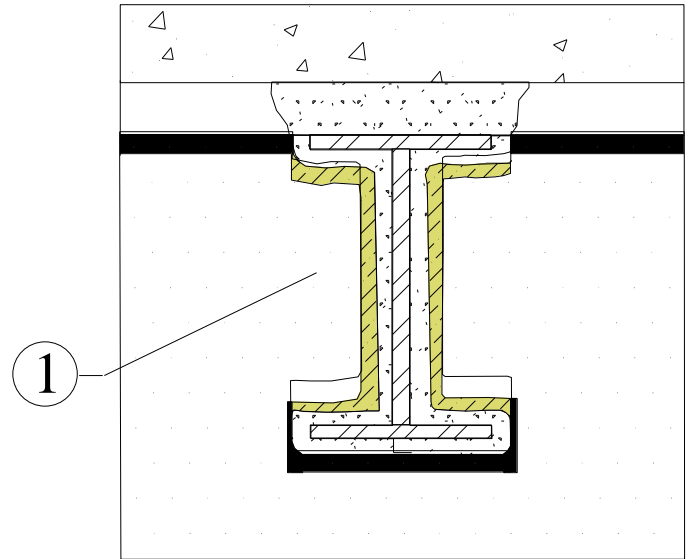

Alternate: Square Cut Gypsum

1) Safti-Seal FRG – Apply Safti-Seal Fire Rated Gasket (FRG) continuous to horizontal deflection track at deck and under beam – width to accommodate specified deflection

2) Mineral Wool – Fill “beam cavity” with min. 4 pcf mineral wool (width of wall framing) compressed a min. 50% filling entire Beam Cavity Pocket/Void

3) Safti-Seal BPG – Contour Cut and apply Safti-Seal Beam Pocket Gasket (BPG) profile to vertical beam “drop” beam drop framing with “foam flange” extending to SFRM continuous

-Fasten with typical steel fasteners a max 8” O/C through FRG portion of BPG profile both sides of wall

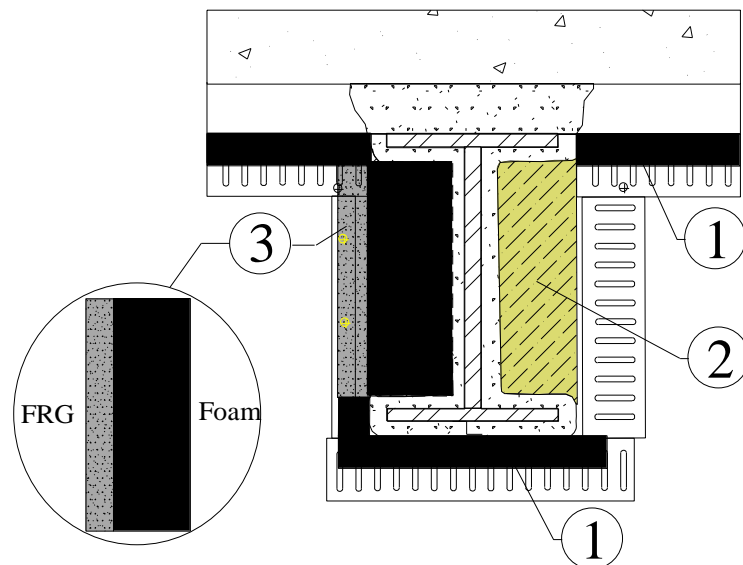



“Horseshoe” Frame/Deflection – Protected I-Beam Penetrations

1) **Finished Square Cut Gypsum** – Square cut gypsum around beam penetration overlapping horizontal FRG applied to deflection gaps at deck and under beam *per specified deflection required and overlapping vertical FRG gasket portion of BPG a min 1/2”*

2) **Safti-Seal BPG** – Safti-Seal Beam Pocket Gasket (BPG) profile “foam” flanges exposed finish (black in color can be painted)

-Max 4.00” Overall Deflection
-Sound & Secure Hidden Steel Pocket Seal

- Do not fasten wall sheathing to “Horseshoe” framing around beam penetration

- Do not fasten vertical stud framing to vertical “beam drop” framing

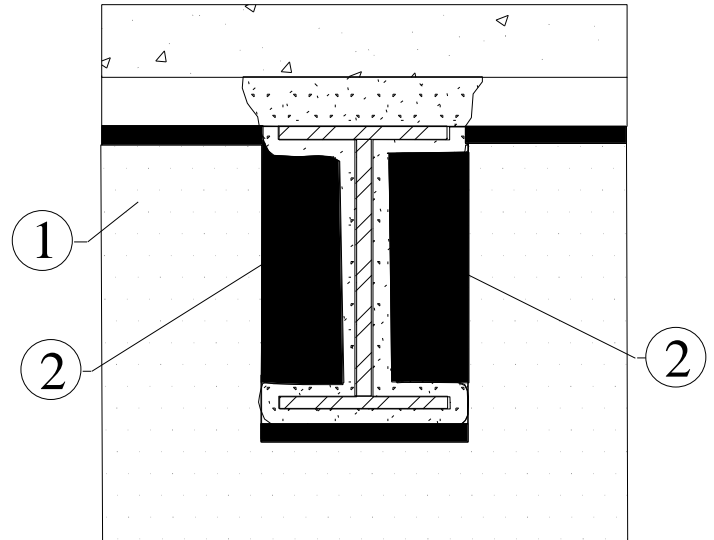



“Horseshoe” Frame/Deflection – Protected I-Beam Penetrations

Comparison Alternates - UL 2079

Max Deflection: 1/16” Compression Only

- 1) Missing Backing Support** – No framing under beam as backing to support to hold joint sealants in place
- 2) Sealant Shearing Failure** - Third-party certified for ***1/16” compression only*** “vertical shearing” of sealants applied to Spray Applied Fire Proofing and Gypsum
- 3) Contour Cut Gypsum** – Max 1/2” to 3/4” gap around beam – consideration how to cut gyp for install and repairs of “split board” to install

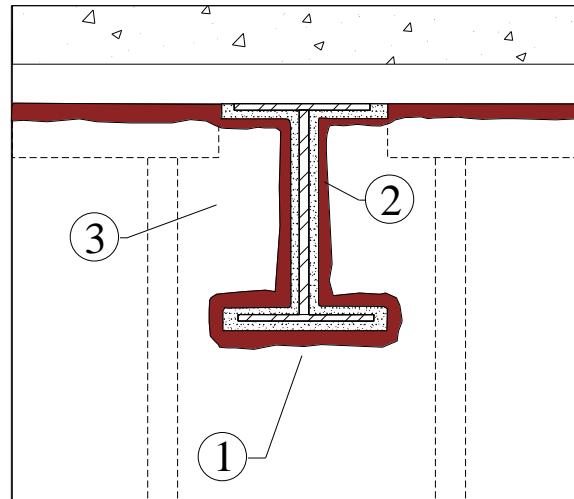

Limited Deflection: Max 3/8” Overall

- 1) Header Framing** – Header framing required to be located min 1” below SFRM applied to beam allowing for additional compressed mineral wool fill below beam as well as in beam cavity and deflection of beam
- 2) Square Cut Drywall** – Square cut drywall edges need be supported by “framed out” metal framing
- 3) Sealant** – Sealant required min 1/8” thickness covering all mineral wool overlapping a min. 1” onto gypsum and 2” onto SFRM Spray Applied Fire Proofing per UL listed requirements

