

Product Profile Dimensions

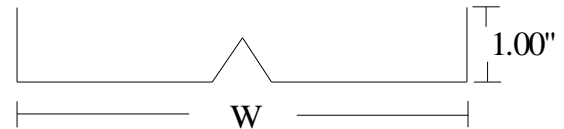

PS53 - "HJC" Universal Header, Jamb, and Cripple Clip

Profile used with single Jamb Stud profile to create header system above or below openings to support vertical and horizontal loads. Profile provides for Jamb Attachment, Header Stiffening/Support, and Cripple Stud Attachment. Reversible design allows for Clip to fit two different flange heights and has stiffening rib centered in web manufactured with minimum G40 coating and cold-formed steel matching relevant ASTM requirements.

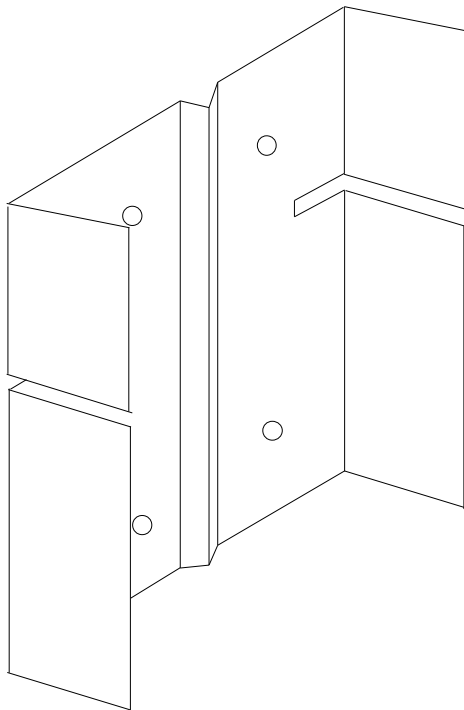

Part #	Header	Clip O/D
362HJC - 54	3 5/8"	3 1/2"
400HJC - 54	4"	3 7/8"
600HJC - 54	6"	5 7/8"

Stock Size fits 2.00" or 3.00" Header Flanges
Stock 16ga (54mil) design thickness
Other Sizes and Gauges available

ASTM & Code Standards

A1003, A653, A924, C645, C754, C955
2015 & 2018 IBC

Leed Points

MR 2.1 & 2.2 - Construction Waste: up to 2pts
MR 4.1 & 4.2 - Recycled Content: up to 2 pts
MR 5.1 & 5.2 - Regional Proximity

Phone: (425) 869-2811 Fax: (425) 869-2300

www.saftiseal.com